



### Main features

Stand-alone unit for independent control of four electrical power control loops. Extremely compact, with independent controls and advanced diagnostics. Used to control power for single-phase and 3-phase loads, including high and low temperature coefficient resistive loads, short wave infrared lamps and transformer primaries.

Unit consisting of:

- Controller
- 30, 60, 80kW solid state relay
- Current transformers
- Fuses-holder (option)
- 4 universal main inputs
- 4 heat/cool independent PID
- 4 main output internally wired to the SSR
- 4 auxiliary analog inputs (option)
- 4 configurable output (option):  
relay / logic / TRIAC / continuous
- 2 configurable relay alarm output
- 2 digital inputs
- Standard digital communication:  
Modbus RTU
- Optional Fieldbus communication:  
Profibus DP, CANopen, Euromap66,  
DeviceNet, Modbus RTU, Modbus TCP,  
Ethernet IP, EtherCAT, ProfiNET
- DIN rail or panel mounting

### Main application

- Thermoforming
- Blowing
- Hot runners for injection presses
- Fiber weaving
- Heat treatment furnaces
- Wood-working machines
- Glass hardening furnaces

### PROFILE

GFX4-IR is a four independent loop controller, designed to manage electrical power.

GFX4 is a compact unit encompassing technological elements such as:

- controller
- solid state relay
- current transformers
- fuses-holders (option)

The final result is a cost saving in terms of space and cabling.

The GFX4-IR is managed by a microprocessor that independently controls the four control loops and also runs functions specifically designed to manage single-phase and 3-phase loads, with low and high temperature coefficient, medium and short wave infrared lamps, control single phase and 3-phase transformers (example, with loads such as Super Kanthal or silicon carbide).

The multiple activation methods are all software-configurable, and include:

- Zero crossing with constant cycle time for conventional loads
- Burst firing with variable cycle time for systems with low thermal inertia, medium wave IR lamps
- Semi-Cycle for short wave IR lamps with reduced flickering (half single cycle)

- Phase angle control with current limit for short wave IR lamps, transformer primaries, with assignment of soft start and soft stop options with limitation of max. rms current.

GFX4IR runs complete diagnostics of current, voltage, and temperature levels:

#### Current

- Total and partial interrupted load alarm
- Function for self-learning of alarm threshold for interrupted load
- SCR in short circuit alarm
- Unbalanced 3-phase line alarm
- Unbalanced 3-phase load alarm

#### Voltage

- Phase loss in case of 3-phase configurations
- Check of correct phase sequence alarm

#### Temperature

- Overtemperature alarm

For complete load control in all applications, various feedback functions have been developed:

- Voltage (V) feedback with maximum voltage limit
- Current (I) feedback with maximum current limit

- Power feedback with maximum power limit

Configuration is changed by setting simple parameters with a software tool that guides the user to a correct and safe configuration.

GFX4-IR communicates with the operator terminals according to the most popular protocols: from the simple and efficient Modbus to (via a second optional fieldbus communication) the by-now indispensable Profibus DP, CANopen, DeviceNet, Modbus RTU, Ethernet Modbus TCP, Ethernet IP, EtherCAT, ProfiNET.

The product comes with a standard configuration that is simple and quick to modify, for example, to assign different functions to outputs.

## **MODELS**

(see table in order code)

3 different sizes, depending on the electric power managed, are available.

### **GFX4-IR 80**

Maximum contemporaneous power up to 80kW@480V.

Each zone can manage up to 19,2 kW. This limit can be extended to 27,3 kW using the "smart power management" (not all the zone contemporaneous).  
Nominal current 40A for zone, not contemporary maximum 57A.

### **GFX4-IR 60**

Maximum contemporaneous power up to 60kW@480V.

Each zone could reach up to 15,3 kW. Nominal current 32A for zone (UL30A). Fuse holder could be provided as an option.

### **GFX4-IR 30**

Maximum contemporaneous power up to 30kW@480V.

Each zone could reach up to 7,6 kW. Nominal current 16A for zone. Fuse holder could be provided as an option.

## **INPUTS**

### **Process analogue**

4 universal process input can accept:

- thermocouple
- thermoresistance
- linear current & voltage.

Input type can be selected by software, no external devices are required.

### **Digital**

2 digital input.

The function can be selected from a wide range, including setpoint selection, MAN/AUTO, alarm memory reset and many other.

### **Incorporated CT**

Four CTs are integrated in the product to control currents delivered to each zone and to manage the related alarms (HB...).

### **Auxiliary analogue (option)**

4 further analogue inputs are available, typically for external current transformer reading.

## **OUTPUTS**

Output alarms configurable via software.

### **Heating control**

For each zone, the heating control is internally linked to the power output, no other connections are necessary.

### **Cooling control (option)**

For each zone, one of four types of cooling output is available:- relay, logic, triac or continuous.

A current transformer is furnished with TRIAC output.

### **Alarms**

Two relay outputs are available, configurable as minimum or maximum alarms.

### **LEDs**

Eight monitoring led are available in order to provide diagnostic information.

RN	RUN state of the CPU
ER	error
DI1	DI1 digital input state
DI2	DI2 digital input state
O1	Output 1 state
O2	Output 2 state
O3	Output 3 state
O4	Output 4 state

By default a different meaning is applicable.

## **POWER**

The solid-state power unit (SSR) is integrated in the product. The SSR is built with 4 pairs of SCR in antiparallel.

### Configurable start-up modes

**ZC** - Zero Crossing constant cycle time (settable in range 1-200sec)

**BF** - Burst Firing variable cycle time (GTT)

**HSC**- Half Single Cycle corresponds to Burst Firing that manages single semi-cycles of conduction or stop cycles.

Useful for reducing flicker with short wave IR loads (applied only to single-phase load or 3-phase open delta 6 leads)

**PA** - Phase Angle that manages the firing angle.

### Load type:

- 4 single-phase
- 3 independent single-phase in open delta
- 1 3-phase open delta, 6 leads
- 1 3-phase delta, 3 leads
- 1 3-phase star without neutral, 3 leads
- 1 3-phase star with neutral, 4 leads

## **FUSES (OPTION)**

The fuses are orderable on the GFX4-IR 30KW and 60kW model.

Thanks to this, you save time, wiring is simplified, and dimensions in the panel are reduced.

## **PROGRAMMING**

The module is configured by setting simple parameters.

No knowledge of programming language is required.

The module can be configured in various ways:

- using GFX-OP
- using GF\_eXpress tool software
- using Industrial PC or PLC.

## **FUNCTIONS**

### **Control**

The Geflex control algorithm works with any type of thermal process.

Different control modes are available: from a simple ON/OFF control to PID single or double acting heat/cool (for cooling, simply indicate the fluid used).

Sophisticated and efficient automatic tuning algorithms for control parameters provide precise process control without the presence of an operator.

### **Alarms**

There are 8 alarm assignable to each single channel or to all (AND / OR logic) and configurable as absolute, relative, direct, reverse, window, latching or not, inhibit at power-on.

### **Diagnostics**

Geflex assures efficient process monitoring from a thermal and electrical point of view, allowing the operator to foresee breakdowns or malfunctions and take timely action (for example, in case the temperature safety limit is exceeded, broken probe, load fault).

The LBA alarm precisely checks the control loop.

### Current read (RMS)

- HB alarm load interrupted or partially interrupted
- Calibration of HB alarm threshold via automatic procedure starting from load current level.

Alarm threshold is determined from settable %

(ex.: if measured current =10A and %=20, HB alarm threshold = 8A)

The procedure includes:

- start of requested power to maximum
- sampling of load current
- return to previous requested power level for 3-phase load, three separate alarm thresholds
- SCR in short circuit alarm
- Load in short circuit or overcurrent alarm
- Unbalanced 3-phase load

### Voltage read (RMS)

- Incorrect phase rotation diagnosis in 3-phase configuration.
- Phase loss alarm in 3-phase load configuration
- Over temperature alarm

The software can be used to define the state of alarm outputs or a preset power level to be supplied in case of broken probe. This assures continuity of service in the individual zone.

### **Tuning**

- Self-tuning: calculation of PID parameters at system start.
- Auto-tuning continuous:continuous adjustment of PID

- Autotuning one-shot: output modulation and event-driven automatic PID parameters re-calculation

### Special functions

- Software Off: disabling of the control, outputs are turned off.
- Inputs\outputs: direct management of inputs/outputs, independently from internal firmware.
- Simulation of four independent Geflex units.
- Smart power management.
- Option:
  - Soft start at timed power-on with or without control of maximum current reactivation after a settable shut-off time.
  - Current limit
  - DT: Delay Triggering 0-90° on first cycle (for inductive loads in modality ZC or BF)
- Option for PA
  - Soft start at timed power-on with or without control of maximum current reactivation after a settable shut-off time.
  - Soft stop at times power-off

- Feedback modes:

### V or V<sup>2</sup>

- Voltage feedback with maximum voltage limit: controls by maintaining constant voltage on the load (proportional to P%\_pid) regardless of changes in line voltage

### I or I<sup>2</sup>

- Current feedback with maximum current limit: controls by maintaining constant current on the load (proportional to P%\_pid) regardless of changes in line voltage or load impedance

### P

- Power feedback with maximum power limit: controls by maintaining constant power on the load (proportional to P%\_pid) regardless of changes in line voltage or load impedance.

You have to set the autocalibration parameter each time you change feedback mode.

## DIGITAL COMMUNICATION

The product is furnished with standard digital communication [PORT 1] used as GFX4 connection to a HMI or Industrial PC.

Also by a dedicated connector (10 pins) it's possible to connect the actual range of Geflex.

A second standard digital communication (PORT 2) configurable by most popular protocol:

CANopen, Euromap66, DeviceNet, Profibus DP, Modbus RTU Modbus TCP, Ethernet IP, EtherCAT, ProfiNET is available as option.

### Net address

Assigned by two rotative selectors.

## GENERAL DESCRIPTION

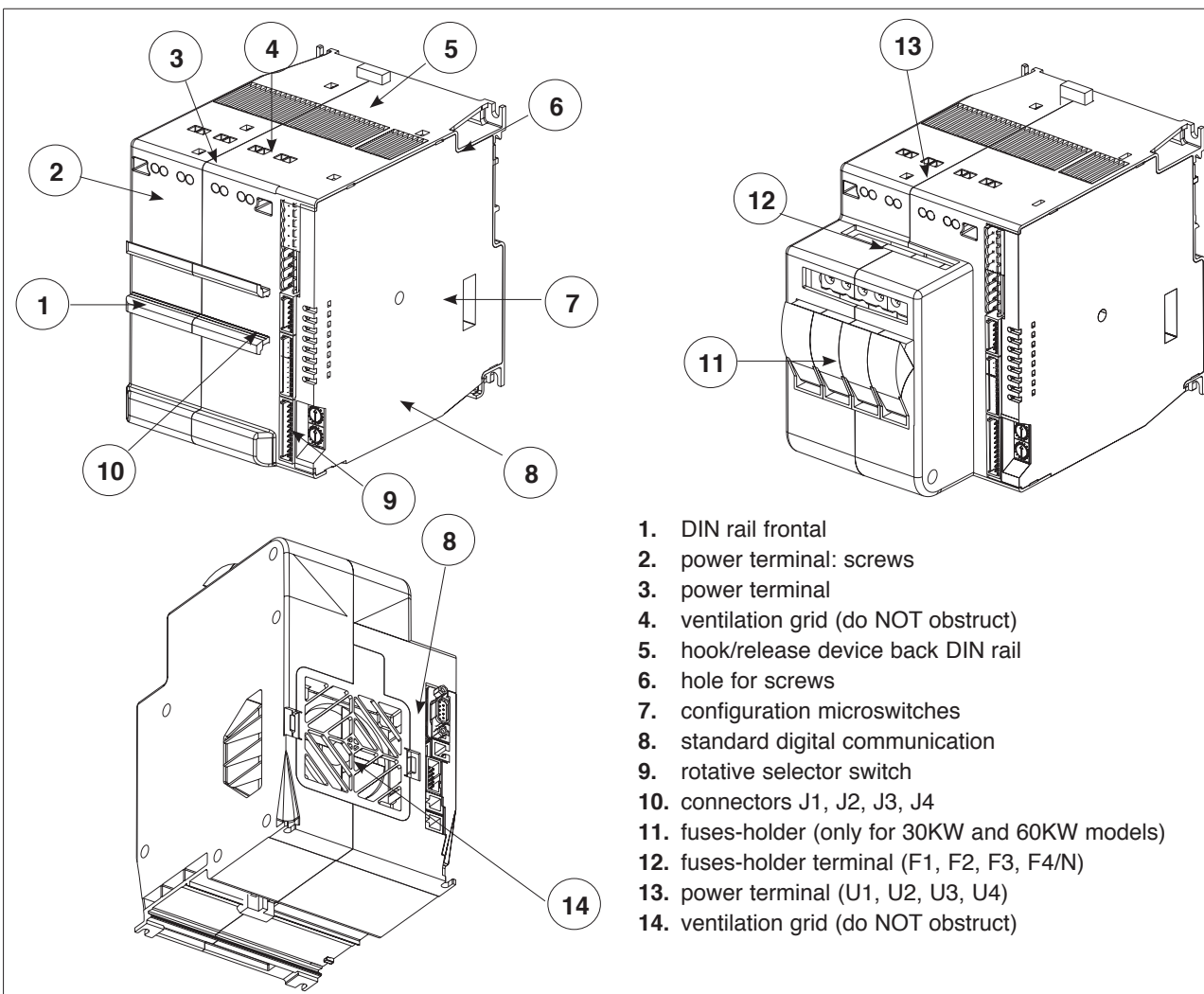

1. DIN rail frontal
2. power terminal: screws
3. power terminal
4. ventilation grid (do NOT obstruct)
5. hook/release device back DIN rail
6. hole for screws
7. configuration microswitches
8. standard digital communication
9. rotative selector switch
10. connectors J1, J2, J3, J4
11. fuses-holder (only for 30KW and 60KW models)
12. fuses-holder terminal (F1, F2, F3, F4/N)
13. power terminal (U1, U2, U3, U4)
14. ventilation grid (do NOT obstruct)

**Trigger modes**

The GFX4-IR provides the following power control modes:

- modulation via variation of phase angle: PA modality
- modulation via variation of number of conduction cycles with "zero crossing" trigger": ZC, BF, HSC modality.

**PA - Phase angle**

This mode manages power on the load by modulating load phase angle  $\theta$

ex: if power to be transferred to the load is 100%,  $\theta = 180^\circ$

ex: if power to be transferred to the load is 50%,  $\theta = 90^\circ$

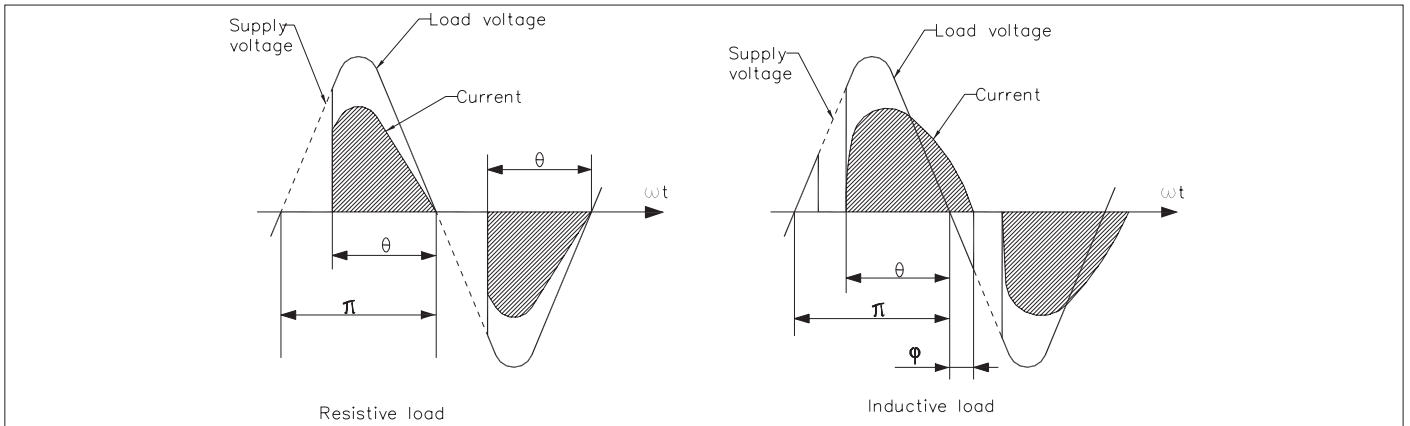

**Zero Crossing mode**

This function eliminates EMC noise. This mode controls power on the load via a series of conduction ON and non conduction OFF cycles.

ZC - constant cycle time ( $T_c \geq 1$  sec, settable from 1 to 200 sec) Cycle time is divided into a series of conduction and non conduction cycles in proportion to the power value to be transferred to the load.

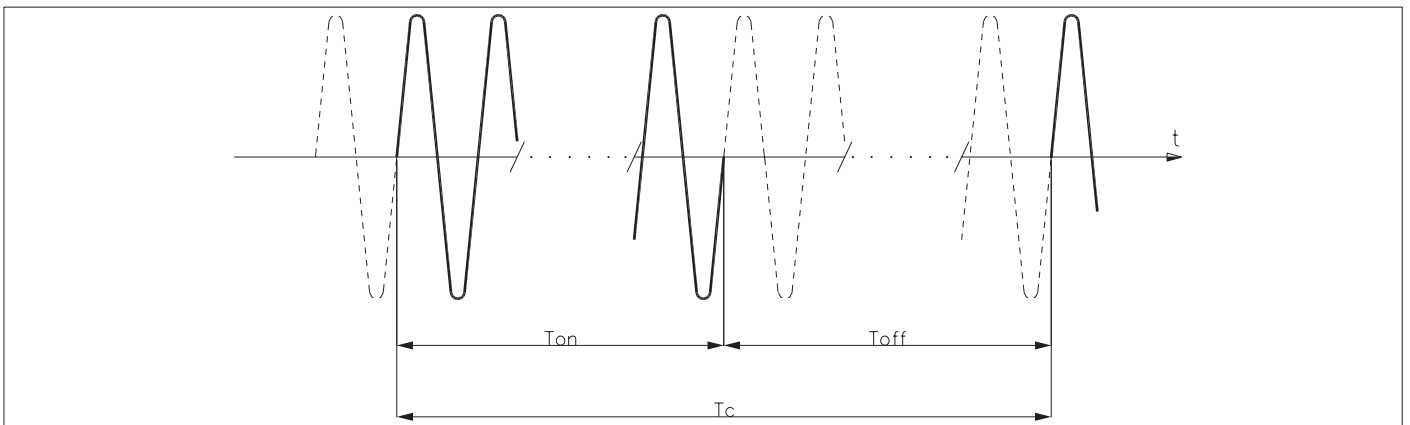

For example, if  $T_c = 10$ sec, if the power value is 20% there is conduction for 2 sec (100 conduction cycles @ 50Hz) and non conduction for 8 sec (400 non conduction cycles @ 50Hz).

**BF - variable cycle time (GTT)**

This mode controls power on the load via a series of conduction ON and non conduction OFF cycles. The ratio of the number of ON cycles to OFF cycles is proportional to the power value to be supplied to the load.

The CT repeat period is kept to a minimum for each power value (whereas in ZC mode the period is always fixed and not optimized).

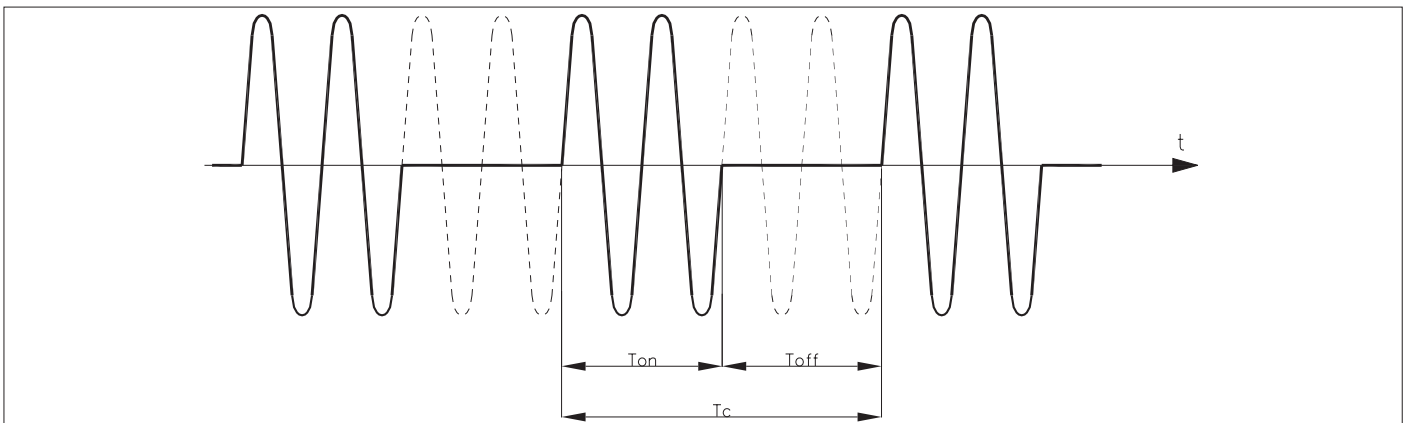

Example of operation in BF mode with power at 50%. A parameter defines the minimum number of conduction cycles settable (from 1 to 10). In the example, this parameter = 2.

### HSC - Half single cycle

This mode corresponds to Burst Firing that includes single conduction cycles and half non-conduction cycles.

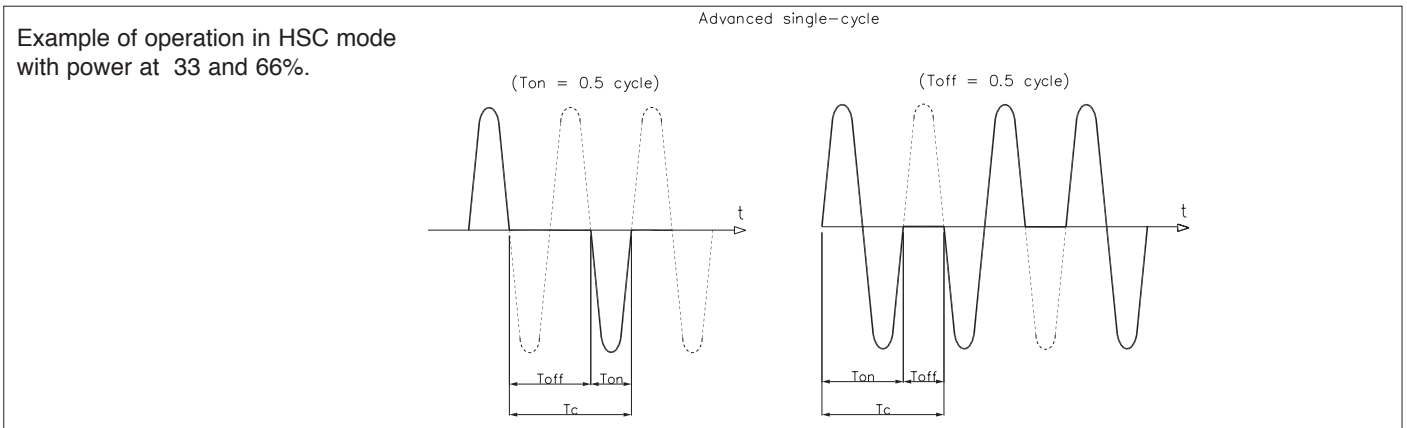

### Softstart or Ramp at power-on

This type of start can be enabled in either phase control or pulse train mode.

With phase control, the increment of firing angle  $\theta$  stops at the corresponding power value to be transferred to the load.

The control of maximum current spike can be enabled during the ramp phase (this is useful in case of short circuit on the load or loads with other temperature coefficients to automatically adjust the start time of the load).

The ramp is automatically re-enabled if the GFX4-IR remains off for a (settable) time.

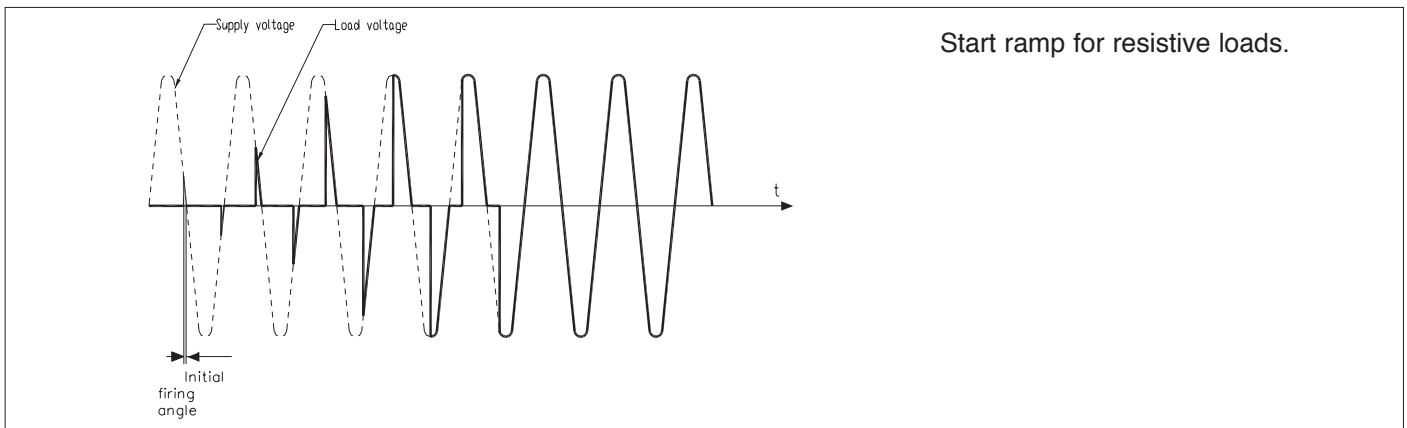

### DT - "Delay triggering" of first cycle (only for control modes ZC, BF)

Settable from  $0^\circ$  to  $90^\circ$ .

Useful for inductive loads (transformer primaries) to prevent current spike that could in certain cases trip the high-speed fuses that protect the SCRs.

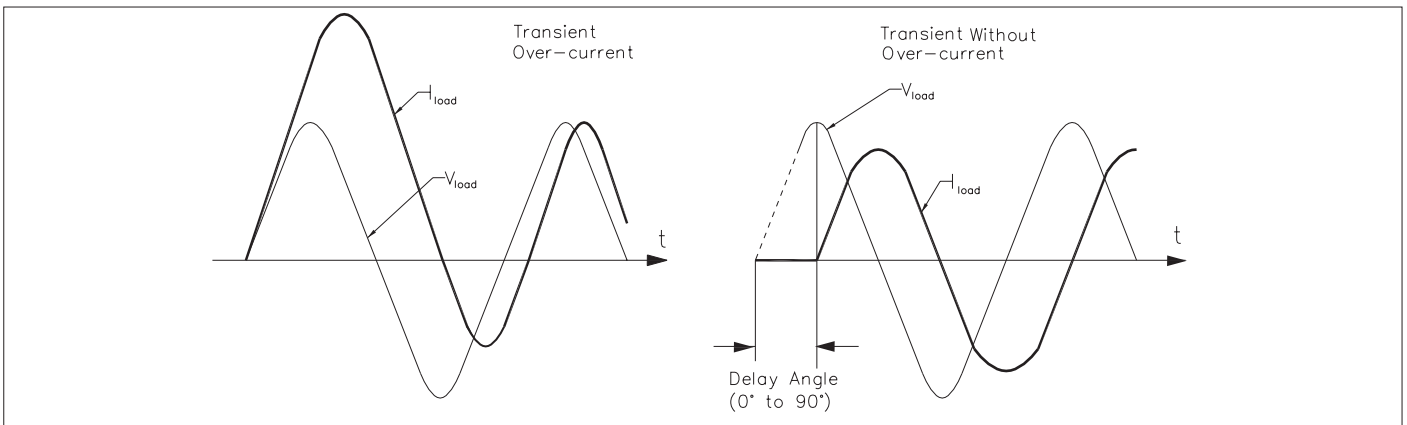

## DIMENSIONS - INSTALLATION

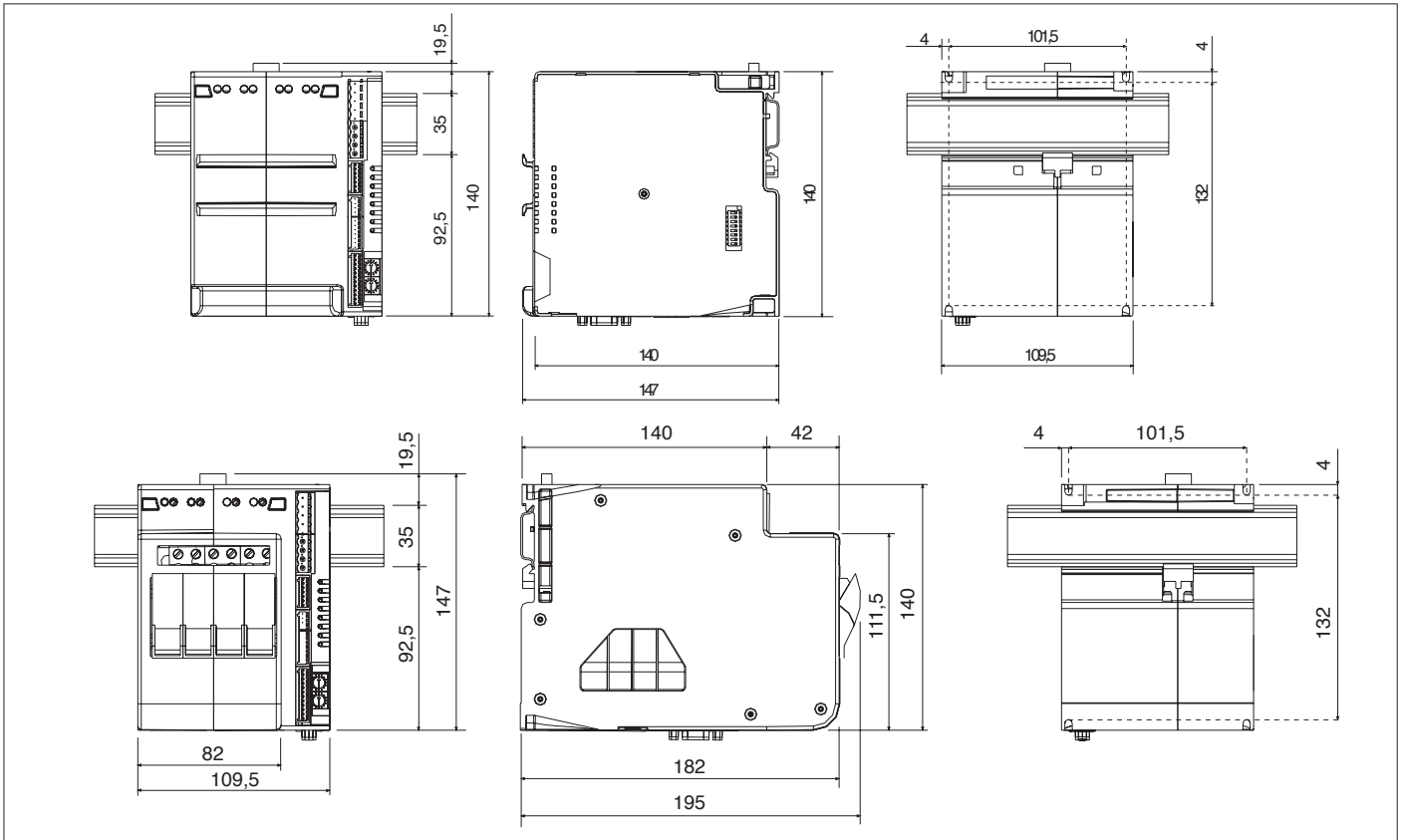

## TECHNICAL DATA

### INPUTS

#### IN1...IN4 [process analog inputs]

Connector: J4

Function: default process variable (configurable)

Sampling time: 120msec the four inputs  
Accuracy: 0,2% FS  $\pm 1$  steps at 25°C.  
(16000 points)

Thermal drift: 0,005% FS/°C

Type

- *Thermocouples ITS90*: J, K, R, S, T, custom (IEC584-1, CEI EN 60584-1, 60584-2). Internal cold junction compensation with automatic compensation.

Selectable temperature range: °C/°F

- *Thermoresistance*: Pt100 DIN 43760  
Max. resistance 20 $\Omega$

Selectable temperature range: °C/°F

- *Voltage*: range 0/12...60mV,  $R_i > 1M\Omega$   
0/0,2...1V,  $R_i > 1M\Omega$  custom 60mV at 32 sections

- *Current*: range 0/4...20mA,  $R_i = 50\Omega$   
custom 20mA at 32 sections

#### IN5...IN8 [auxiliary analogue inputs]

Connector: J3

Function: default analog inputs reading

Sampling time: 480msec per TC, voltage  
Accuracy: 1% FS  $\pm 1$  steps at 25°C.

Type

- *Thermocouple ITS90*: J, K, R, S, T, custom (IEC584-1, CEI EN 60584-1, 60584-2).

Internal cold junction compensation with automatic compensation.

- *Voltage*: range 0/12...60mV,  $R_i > 1M\Omega$   
Measurement of line Voltage and Current

- RMS current measurement function

Load current read; minimum measurable current: 2A (30kW model), 4A (60kW model), 6A (80kW model)

- Accuracy of RMS current measurement  
2% f.s. at room temperature of 25°C in ZC and BF firing modes; 3% f.s. in PA mode with phase angle  $>90^\circ$ , 10% f.s. with phase angle  $<90^\circ$

- RMS voltage measurement function  
Line voltage read; (acquisition of voltage values is valid for voltage in range 90...530VAC)

- Accuracy of RMS voltage measurement  
1% f.s. with neutral connected; 3% f.s. without neutral.

- Current and voltage sampling time  
0.25 ms

#### DI1, DI2 [digital inputs]

Connector: J2

Function: default not enable (configurable)

Type

PNP, 24Vdc, 8mA (isol. 3500V)

## OUTPUTS

### OUT 1...4 [heating control]

*outputs connected to solid state relay*  
Function: default heating control (configurable)

### OUT 5...8 [cooling control]

Connector: J1  
Function: default cooling control (configurable)  
Type  
• Relay: NO, max 3A, 250V/30Vdc,  $\cos\varphi = 1$  resistive load  
• Logic: 24Vdc, 35mA  
• Continuous - voltage: 0/2...10V,  $\pm 10V$ , max 25mA short circuit protection  
- current: 0/4...20mA, 500 $\Omega$  max  
- insulation: 1500V  
• Triac: 230V/4Amp AC5 (0,8A for four) (1,6A for two)

### OUT 9...10 [alarms]

Connector: J1a/J1  
Function: default alarms (configurable)  
Type  
Relay: NO, max 5A, /30Vdc,  $\cos\varphi = 1$

## LEDs

RN .....RUN state of the CPU  
ER .....error  
DI1 .....DI1 digital input state  
DI2 .....DI2 digital input state  
O1 .....Out.1 main input state  
O2 .....Out.2 main input state  
O3 .....Out.3 main input state  
O4 .....Out.4 main input state

## COMMUNICATION PORTS

### PORT 1 [local bus]

Connectors: S1/S2/S3  
Function: local bus  
Protocol:  
Modbus RTU  
Baud Rate: 115Kbps (default) setting 1200...115Kbps  
Node address: setting by double rotative selector  
Connectors S1/S2: 2xRJ10 pins for flat cable 4-4, RS485 2 wires insul. 1500V  
Connectors S3: 10 pins for flat cable

### PORT 2 [fieldbus]

Connectors: S4 / S5  
Function: external fieldbus  
Protocol:  
Modbus RTU \_\_\_\_\_ 115Kbps  
CANopen/Euromap 66 \_ 10K...1Mbps  
Profibus DP \_\_\_\_\_ 9,6...12Mbps  
DeviceNet \_\_\_\_\_  
125K..500Kbps  
Ethernet IP/Modbus TCP 10/100Mbps  
EtherCAT \_\_\_\_\_ 100Mbps  
ProfiNET \_\_\_\_\_ 100Mbps

See accessories

## MICROSWITCHES

8 dip switches are available to select wiring mode and different functionalities.

## POWER

### Load type

**AC51**  
resistive or low-inductance loads  
**AC55b**  
short-wave infrared lamp (SWIR)  
**AC56a**  
ransformers, resistive loads with high temperature coefficient

### Switch-on modes

**ZC**  
Zero crossing constant cycle time (1-200sec)  
**BF**  
Burst Firing variable cycle time (GTT) minimum or optimized  
**HSC**  
Half Single Cycle corresponds to Burst Firing that manages Semi-cycles of on and off. Useful to reduce flickering with short-wave infrared loads  
**PA**  
Phase Angle

### SSR [integrated power element]

Rated voltage: 480Vac  
Work voltage range: 90...530Vac  
Non-repetitive voltage: 1200Vp  
Rated frequency: 50/60Hz self-adjusting  
Rated current AC51 for zone  
GFX4 30KW: 16A  
GFX4 60KW: 32A  
GFX4 80KW: 40A (single channel 57A)  
Rated current AC55b for zone  
GFX4 30KW: 8A  
GFX4 60KW: 16A  
GFX4 80KW: 20A  
for applications in which you can set a minimum power output limit (ex: Lo.P = 10%) by also limiting the lamp power variation speed with gradient limit (ex: G.out = 20%, PS.TM = 20s).  
Under these conditions, the nominal currents shown on the table can be raised up to the values indicated for AC51 type loads.

Rated current AC56b for zone  
GFX4 30KW: 12A  
GFX4 60KW: 25A  
GFX4 80KW: 32A Trigger mode: ZC, BF with DT (Delay Triggering), PA with softstart  
Non-repetitive overcurrent [t=20msec]  
GFX4 30KW: 400A  
GFX4 60KW: 600A  
GFX4 80KW: 1150A  
I<sup>2</sup>t per fusione [t=1...10msec]  
GFX4 30KW: 645A<sup>2</sup>s  
GFX4 60KW: 1010A<sup>2</sup>s  
GFX4 80KW: 6600A<sup>2</sup>s  
Dv/dt critical with deactivated output: 10,000V/ $\mu$ s High static dv/dt  
Rated insulation voltage In/Out: 4000V

## GENERAL FEATURES

Power supply: 24Vdc  $\pm 25\%$ , max 8VA  
Protection class: IP20  
Working temperature range: 0...50°C (see dissipation curves)  
Storage temperature range: -20...+70°C  
Relative humidity: 20...85% UR non-condensing  
Installation: DIN EN50022 rail or panel by screw  
Dimensions: see dimensions and installation  
Weight:  
models 30/60/80: 1200g.  
models 30/60 with fusesolder: 1600g.

# ELECTRICAL CONNECTIONS

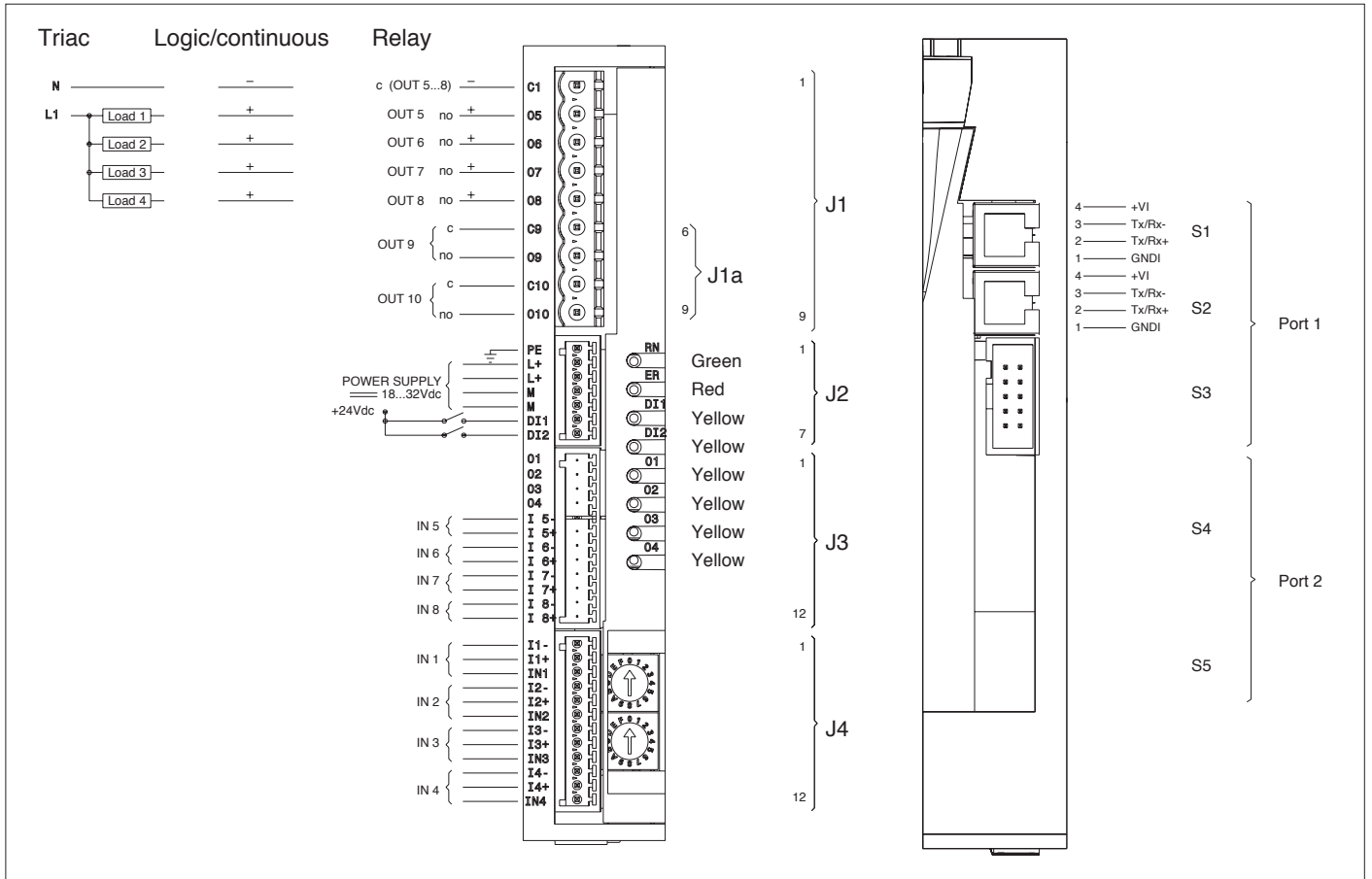

## power

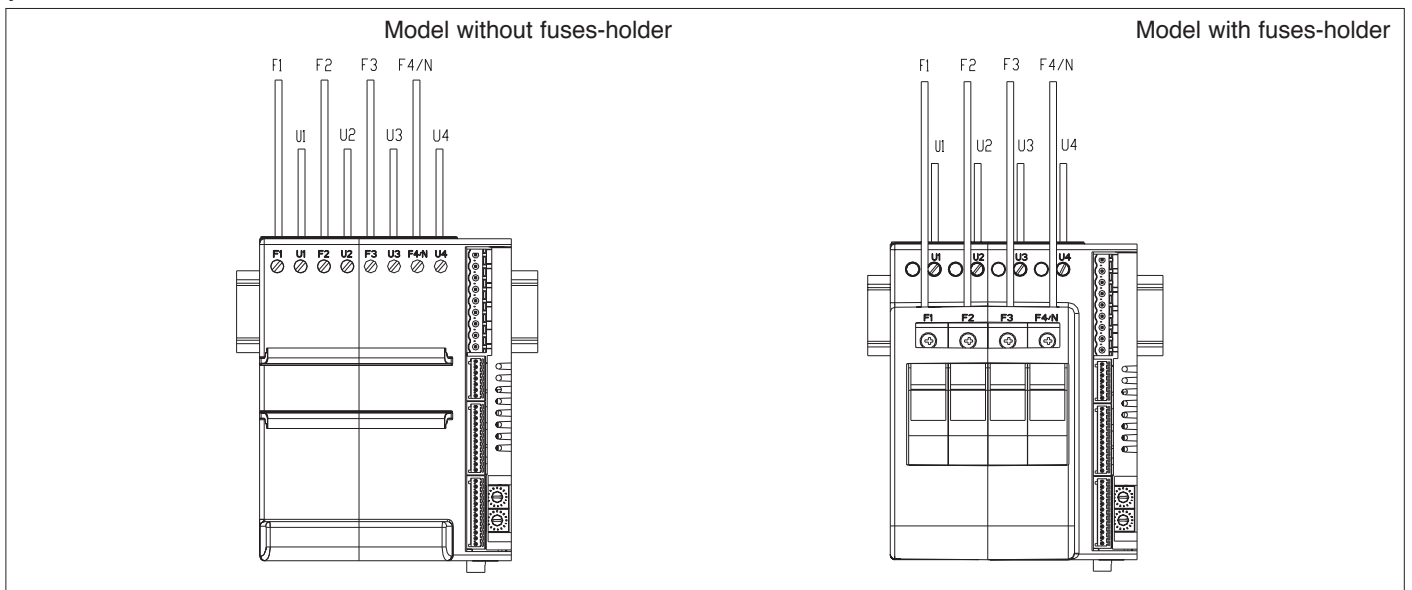

Model	30kW		60kW		80kW	
max current	16A		32A (30A)*		57A (40A)*	
rigid	0,2 - 6mm <sup>2</sup>	24-10AWG	0,2 - 6mm <sup>2</sup>	24-10AWG	0,5 - 16mm <sup>2</sup>	20-6AWG
flexible	0,2 - 4mm <sup>2</sup>	24-10AWG	0,2 - 4mm <sup>2</sup>	24-10AWG	0,5 - 10mm <sup>2</sup>	20-7AWG
	0,25 - 4mm <sup>2</sup>	23-10AWG	0,25 - 4mm <sup>2</sup>	23-10AWG	0,5 - 10mm <sup>2</sup>	20-7AWG
	0,25 - 4mm <sup>2</sup>	23-10AWG	0,25 - 4mm <sup>2</sup>	23-10AWG	0,5 - 10mm <sup>2</sup>	20-7AWG
	0,5 - 0,6Nm		0,5 - 0,6Nm		1,2 - 1,5Nm	

\* UL certification

## ORDER CODE



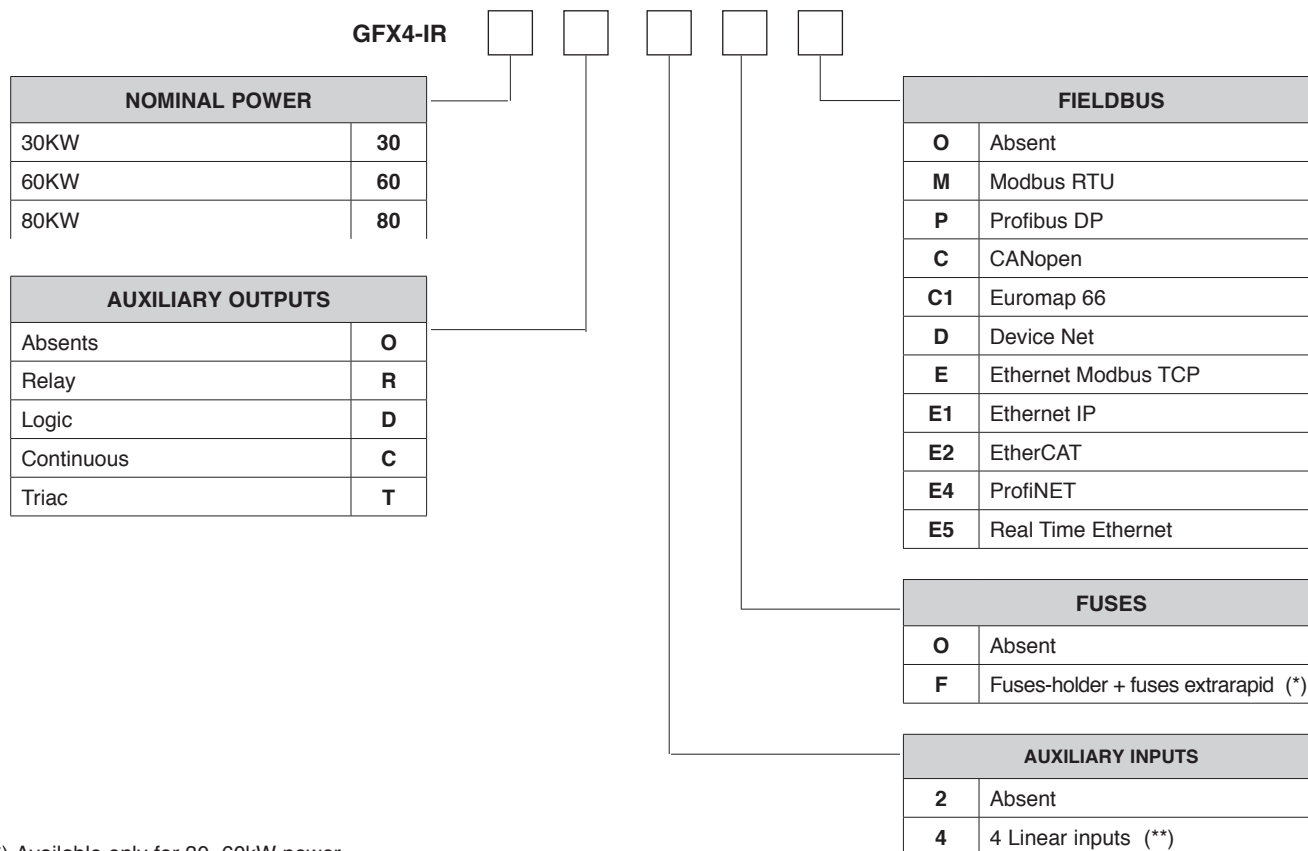

Model GFX4	Current (Amp)		Voltage (Vac)			Power (kW)		
	max for channel		range	nominal	working	total contemporary	single channel	max for single channel
30 (4x16A)	16		24...530	480	110	(4x16x110) 7	(16x110) 1,7	(1x16x110) 1,7
					230	(4x16x230) 14,7	(16x230) 3,6	(1x16x230) 3,6
					400	(4x16x400) 25,6	(16x400) 6,4	(16x400) 6,4
					480	(4x16x480) 30,7	(16x480) 7,6	(1x16x480) 7,6
60 (4x32A) (4x30A)*	32 (30)*		24...530	480	110	(4x32x110) 14	(32x110) 3,5	(32x110) 3,5
					230	(4x32x230) 29,4	(32x230) 7,3	(1x32x230) 7,3
					400	(4x32x400) 51,2	(32x400) 12,8	(1x32x400) 12,8
					480	(4x32x480) 61,4	(32x480) 15,3	(1x32x480) 15,3
80 (4x40A)	40*	57	24...530	480	110	(4x40x110) 17,6	(40x110) 4,4	(1x57x110) 62,7
					230	(4x40x230) 36,8	(40x230) 9,2	(1x57x230) 13,1
					400	(4x40x400) 64	(40x400) 16	(1x57x400) 22,8
					480	(4x40x480) 76,8	(40x480) 19,2	(1x57x480) 27,3

\* Certification UL



(\*) Available only for 30, 60kW power

(\*\*) Option NOT available with Fieldbus E1 or E2 or E4 or E5

	<p>Conformity TC N° РУД-ИТ.АЛ32.б.01762</p>
	<p>Conformity C/CSA/US CoFC no. 70043834</p>
	<p>Conformity C/UL/US File no. E243386</p>
	<p>The instrument conforms to the European Directives 2004/108/CE and 2006/95/CE with reference to the generic standards:  - <b>EN 60947-4-3</b> (Product) - <b>EN 61010-1</b> (safety)</p>